



Pressure Switches

Series 1 Pressure Switch



Key Features

- Field Adjustable
- High, Low, Differential & Vacuum Pressure Switch options available
- All Anodized Aluminum Construction
- 316SS Pressure Ports Available
- All Markings Laser Engraved into body for long lasting durability and visibility
- Multiple Electrical Connections Available
- 11amp UL recognized micro switch standard, gold plated contacts and 5amp micro switch also available
- UL & cUL Approved
- NEMA 4, 4x, 13

How to Order

(Example: Part Number 1G10N1.43)

1 G 10 N1 . 43

- Range**
- 01 2 - 15 psi
 - 03 5 - 75 psi
 - 43 15 - 200 psi
 - 53 50 - 450 psi
 - 62 50 - 1000 psi
 - 63 100 - 1750 psi
 - 71* 100 - 1800 psi
 - 72* 200 - 2500 psi
 - 73* 350 - 3250 psi
 - 74* 350 - 4250 psi
 - 83** 400 - 4000 psi
 - 84** 500 - 5000 psi

- Diaphragm**
- N1 Nitrile Polyamide
 - F1 Viton Polyamide
 - F2 Viton Stainless Steel
 - F6** Viton Polyamide
 - N9* Nitrile SST Piston Teflon

- Electrical Connection**
- 10 18" Free leads
 - 11 DIN 43650/IP65
 - 42 Terminal Strip for Wiring

- Pressure Connection**
- A AL 1/2"-14 NPT
 - C 316SS 1/4"-18 NPT
 - D AL 1/4"-18 NPT
 - G AL 1/4"-18 NPT
 - H** 316SS 1/4"-18 NPT
 - P* AL 1/4"-18 NPT
 - Z 316SS1/2"-14 NPT

Operating Specifications

- Adjustment Range:** See Table Below for Options
Circuit Form: SPDT
Electrical Ratings: 11A (RES/IND) - 1/4 HP @125 OR 250VAC
 5A RES, 3A IND @ 28VDC
 .5A RES @ 28VDC
 Optional: 100mA @125VAC, 0.25A @ 6VDC
Pressure Connection: See Ordering Chart Adjacent
Temperature Range: -30°F to 160°F (-34°C to 71°C)
Diaphragm Material: See Ordering Chart Adjacent
Electrical Connection: See Ordering Chart Adjacent
Multi-Conductor UL 22464, CSA T1 18AWG PVC insulated per UL
Cable: 1007, secured with a nylon liquid tight connector
Cycle Life: Model 1A, 1C, 1G, 1Z, 1H for moderate to low cycling, Model 1P for high cycling applications

Options:

- (Example: Part Number 1G10N1.43.5)
 .5 5A Micro Switch
 * Available only for model 1P (Piston Pressure Switch)
 ** Available only for model 1H (S.S. Piston Pressure Switch)

Model	Range ID Number	Switch Adjustment Range		Dead Band Approx.		Max System		Proof Test	
		psi	bar	psi	bar	psi	bar	psi	bar
1A	.01	2 - 15	0.138 - 1.03	0.2 - 2	0.014 - 0.138	500	34.5	1000	68.9
	.03	5 - 75	0.34 - 5.17	0.5 - 6	0.034 - 0.414	750	51.7	1000	68.9
	.43	15 - 200	1.03 - 13.79	2 - 15	0.138 - 1.03	1000	68.9	1250	86.2
1C	.53	50 - 450	3.45 - 31.03	5 - 30	0.345 - 2.07	1500	103.4	3000	206.8
	.62	50 - 1000	3.45 - 68.95	10 - 50	0.69 - 3.45	2000	137.9	5000	344.7
1G	.63	100 - 1750	6.89 - 120.66	15 - 100	1.03 - 6.89	3000	206.8	5000	344.7
	.64	200 - 2500	13.79 - 172.37	20 - 150	1.38 - 10.34	3000	206.8	5000	344.7
1Z	.71	100 - 1800	6.89 - 124.11	25 - 125	1.72 - 8.62	5000	344.7	10000	689.5
	.72	200 - 2500	13.79 - 172.37	30 - 150	2.07 - 10.34	5000	344.7	10000	689.5
	.73	350 - 3250	24.13 - 224.09	50 - 350	3.45 - 24.13	7500	517.1	10000	689.5
	.74	350 - 4250	27.58 - 310.27	80 - 350	5.52 - 24.13	7500	517.1	10000	689.5
1P	.83	400 - 4000	27.58 - 275.79	75 - 450	5.17 - 31.03	5000	344.7	10000	689.5
	.84	500 - 5000	34.47 - 344.74	75 - 500	5.17 - 34.74	7500	517.1	10000	689.5

Wiring Diagram

DIN43650

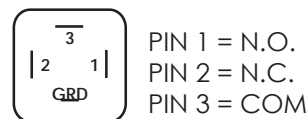

18" Free leads

- BLUE = N.O.
- RED = N.C.
- BROWN = COM
- GREEN = GRD



Pressure Switches

Series 1 Pressure Switch

Low Pressure Switch

Part Number	1G10N1.12	1G10N1.14
Adj. Range	0.36 - 3.61 psi (10" - 100" WC)	2 - 16 psi (55" - 443" WC)
Deadband	0.018- 0.108 psi (0.5" - 3" WC)	0.072- 0.25 psi (2" - 7" WC)
Proof Test	250 psi	250 psi



Terminal Strip

Part Number 1X42XX.XX

Anodized aluminum terminal strip is for wiring a 1/2-14 FNPT conduit fitting. This option is available for any pressure ranges including the differential, vacuum, and high pressure switches.

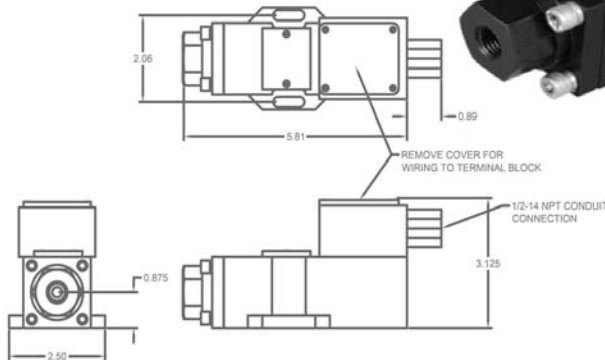

How to Order

(Example: Part Number 1G10N1.43)

1 G 10 N1 . 43

Range

- 01 2 - 15 psi
- 03 5 - 75 psi
- 43 15 - 200 psi
- 53 50 - 450 psi
- 62 50 - 1000 psi
- 63 100 - 1750 psi
- 71* 100 - 1800 psi
- 72* 200 - 2500 psi
- 73* 350 - 3250 psi
- 74* 350 - 4250 psi
- 83** 400 - 4000 psi
- 84** 500 - 5000 psi

Diaphragm

- N1 Nitrile Polyamide
- F1 Viton Polyamide
- F2 Viton Stainless Steel
- F6** Viton Polyamide
- N9* Nitrile SST Piston Teflon

Electrical Connection

- 10 18" Free leads
- 11 DIN 43650/IP65
- 42 Terminal Strip for Wiring

Pressure Connection

- A AL 1/2"-14 NPT
- C 316SS 1/4"-18 NPT
- D AL 1/4"-18 NPT
- G AL 1/4"-18 NPT
- H** 316SS 1/4"-18 NPT
- P* AL 1/4"-18 NPT
- Z 316SS 1/2"-14 NPT

Options:

(Example: Part Number 1G10N1.43.5)
.5 5A Micro Switch

- * Available only for model 1P (Piston Pressure Switch)
- ** Available only for model 1H (S.S. Piston Pressure Switch)

Dimensional Specifications

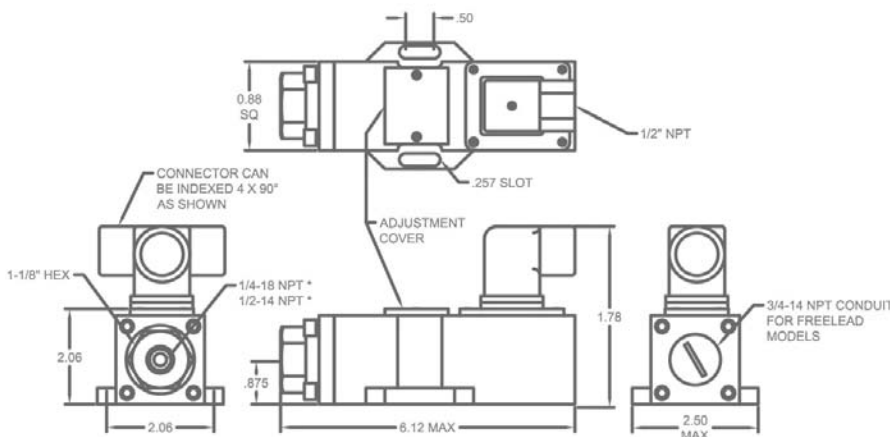



Pressure Switches

Series 1 Pressure Switch

Differential Pressure Switch

Part Number	1DXXF1.02	1DXXF1.04
Adj. Range	2 - 20 psi	5 - 95 psi
Max System	400 psi	400 psi
Proof Hi/Lo	1000 psi	1000 psi
Proof Lo/Hi	1000 psi	1000 psi
Pressure Port	AL 1/4-18 FNPT	AL 1/4-18 FNPT



**Also available in 316SS 1/4-18 FNPT process fittings
(P/N: 1DCXXX.XX)

Electrical Connection

10 - 18" Free leads 11 - DIN 43650/IP65

Vacuum Switch

Part Number	1VXXN9.91
Vacuum Range	1 - 28 inHg
Deadband	0.75- 1.50 inHg
Proof Test	300 psi
Pressure Port:	AL 1/8-27 FNPT

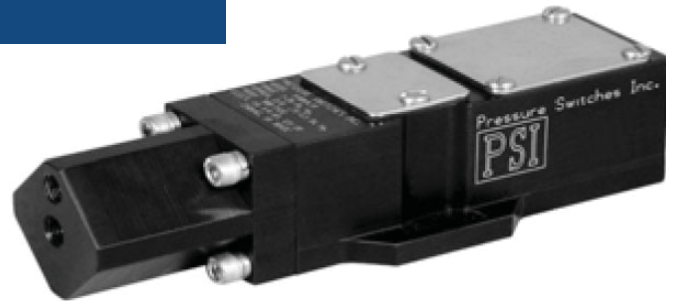

Operating Specifications

- Adjustment Range:** See Table on Page 1 for Options
- Circuit Form:** SPDT
- Electrical Ratings:** 11A (RES/IND) - 1/4 HP @125 OR 250VAC
5A RES, 3A IND @ 28VDC
.5A RES @ 28VDC
Optional: 100mA @125VAC, 0.25A @ 6VDC
- Pressure Connection:** See Ordering Chart on Page 1 for Options
- Temperature Range:** -30°F to 160°F (-34°C to 71°C)
- Diaphragm Material:** See Ordering Chart on Page 1 for Options
- Electrical Connection:** See Ordering Chart on Page 1 for Options
- Multi-Conductor Cable:** UL 22464, CSA T1 18AWG PVC insulated per UL 1007, secured with a nylon liquid tight connector
- Cycle Life:** Model 1A, 1C, 1G, 1Z, 1H for moderate to low cycling, Model 1P for high cycling applications

Key Features

- Field Adjustable
- High, Low, Differential & Vacuum Pressure Switch options available
- All Anodized Aluminum Construction
- 316SS Pressure Ports Available
- All Markings Laser Engraved into body for long lasting durability and visibility
- Multiple Electrical Connections Available
- 11amp UL recognized micro switch standard, gold plated contacts and 5amp micro switch also available
- UL & cUL Approved
- NEMA 4, 4x, 13



Pressure Switches

Series 2 Pressure Switch



Key Features

- Field Adjustable
- Compact Design
- All Anodized Aluminum Construction
- 31 6SS Pressure Ports Available
- All Markings Laser Engraved into body for long lasting durability and visibility
- Multiple Electrical Connections Available
- 1 amp UL recognized micro switch standard, gold plated contacts and 5amp micro switch also available
- UL & cUL Approved
- NEMA 4, 4x, 13

How to Order

(Example: Part Number 2G11N1.63)

2 G 11 N1 . 63

Range

- 01 2 - 20 psi
- 03 5 - 95 psi
- 43 15 - 200 psi
- 53 50 - 450 psi
- 62 50 - 1000 psi
- 63 100 - 1800 psi
- 71* 100 - 1800 psi
- 72* 200 - 2500 psi
- 73* 350 - 3250 psi
- 74* 400 - 4500 psi

Diaphragm

- N1 Nitrile Polyamide
- F1 Viton Polyamide
- F2 Viton Stainless Steel
- N9* Nitrile SST Piston Teflon

Electrical Connection

- 10 18" Free leads
- 11 DIN 43650/IP65
- 16 Liquid tight Connector
- 52 MS 3102R 12S-3P (2PIN)
- 53 MS 3102R 14S-7P (3PIN)

Pressure Connection

- A AL 1/2"-14 NPT
- C 316SS 1/4"-18 NPT
- G AL 1/4"-18 NPT
- P* AL 1/4"-18 NPT
- Z 316SS1/2"-14 NPT

Options:

(Example: Part Number 2G11N1.63.B)

- .1 MS33649-4 Pressure Fitting
- .2 Gold Contact Switch
- .5 5A Micro Switch
- .B Base bracket for mounting

* Available only for model 2P (Piston Pressure Switch)

Operating Specifications

Adjustment Range	See Table Below for Options
Circuit Form	SPDT
Electrical Ratings	11A (RES/IND) - 1/4 HP @125 OR 250VAC 5A RES, 3A IND @ 28VDC .5A RES @ 28VDC Optional: 100mA @125VAC, 0.25A @ 6VDC
Pressure Connection	See Ordering Chart Adjacent for Options
Temperature Range	-30°F to 160°F (-34°C to 71°C)
Diaphragm Material	See Ordering Chart Adjacent for Options
Electrical Connection	See Ordering Chart Adjacent for Options
Multi-Conductor Cable	UL 22464, CSA T1 18AWG PVC insulated per UL 1007, secured with a nylon liquid tight connector
Cycle Life	Model 2A, 2C, 2G, 2Z for moderate to low cycling Model 2P for high cycling applications

Model	Range ID Number	Switch Adjustment Range		Dead Band Approx.		Max System		Proof Test	
		psi	bar	psi	bar	psi	bar	psi	bar
2A 2Z	.01	2 - 20	0.138 - 1.38	0.2 - 2	0.014 - 0.138	500	34.5	1000	68.9
	.03	5 - 95	0.34 - 6.55	1 - 6	0.069 - 0.414	750	51.7	1000	68.9
2C 2G	.43	15 - 200	1.03 - 13.79	2 - 15	0.138 - 1.03	1000	68.9	1250	86.2
	.53	50 - 450	3.45 - 31.03	5 - 30	0.345 - 2.07	1500	103.4	3000	206.8
2C 2G	.62	50 - 1000	3.45 - 68.95	10 - 50	0.69 - 3.45	2000	137.9	5000	344.7
	.63	100 - 1750	6.89 - 120.66	20 - 100	1.38 - 6.89	3000	206.8	5000	344.7
2P	.71	100 - 1800	6.89 - 124.11	25 - 125	1.72 - 8.62	5000	344.7	10000	689.5
	.72	200 - 2500	13.79 - 172.37	30 - 150	2.07 - 10.34	5000	344.7	10000	689.5
	.73	350 - 3250	24.13 - 224.09	50 - 350	3.45 - 24.13	7500	517.1	10000	689.5
	.74	400 - 4500	27.58 - 310.27	80 - 350	5.52 - 24.13	7500	517.1	10000	389.5

Dimensional Specifications

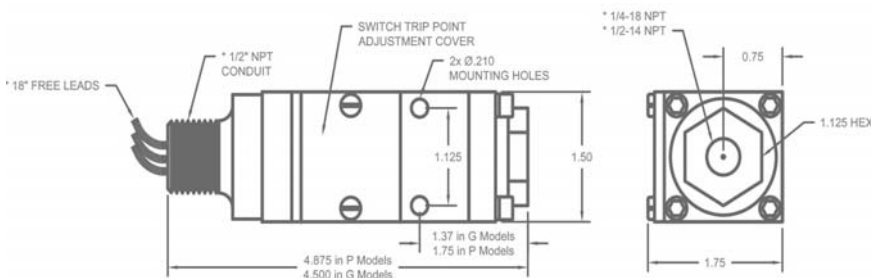

Wiring Diagram

DIN43650

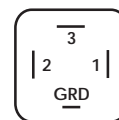

- PIN 1 = N.O.
- PIN 2 = N.C.
- PIN 3 = COM

18" Free leads

- BLUE = N.O.
- RED = N.C.
- BROWN = COM
- GREEN = GRD



Pressure Switches

Series 6 Pressure Switch



Key Features

- Explosion Proof, Rated for Hazardous Areas
- Field Adjustable
- Low Pressure Switch Available
- All precision machined Anodized aluminum Construction
- 316SS Pressure Ports Available
- All Markings Laser Engraved into body for long lasting durability and visibility
- 11 amp UL recognized micro switch standard, gold plated contacts and 5amp micro switch also available
- UL Approved
- NEMA 4, 4x, 7, 9

Operating Specifications

Adjustment Range	See Table Below for Options
Circuit Form	SPDT (12)
Electrical Ratings	11A (RES/IND) - 1/4 HP @125/250VAC 5A RES @ 30VDC 2x 11A (RES/IND) - 1/4 HP @125/250VAC 5A RES @ 30VDC
Pressure Connection	See Ordering Chart Adjacent for Options
Temperature Range	-30°F to 160°F (-34°C to 71°C)
Diaphragm Material	See Ordering Chart Adjacent for Options
Electrical Connection	See Ordering Chart Adjacent for Options

Model	Range ID Number	Switch Adjustment Range		Dead Band Approx.		Max System		Proof Test	
		psi	bar	psi	bar	psi	bar	psi	bar
6A 6Z	.01	2 - 15	0.138 - 1.03	0.2 - 4	0.014 - 0.275	500	34.5	1000	68.9
	.03	5 - 75	0.34 - 5.17	0.5 - 8	0.034 - 0.551	750	51.7	1000	68.9
6C 6G	.43	15 - 200	1.03 - 13.79	2 - 18	0.138 - 1.24	1000	68.9	1250	86.2
	.53	50 - 450	3.45 - 31.03	5 - 33	0.345 - 2.27	1500	103.4	3000	206.8
6C 6G	.62	50 - 1000	3.45 - 68.95	10 - 55	0.69 - 3.79	2000	137.9	5000	344.7
	.63	100 - 1750	6.89 - 120.66	15 - 110	1.03 - 7.58	3000	206.8	5000	344.7
	.64	200 - 2500	13.79 - 172.37	20 - 175	1.38 - 12.06	3000	206.8	5000	344.7
6P	.73	350 - 3250	24.13 - 224.09	50 - 400	3.45 - 27.58	7500	517.1	10000	689.5
6H	.83	400 - 4000	27.58 - 275.29	75 - 500	5.17 - 34.74	5000	344.7	10000	689.5
	.84	500 - 5000	34.47 - 344.74	75 - 500	5.17 - 34.74	7500	517.1	10000	689.5

Low Pressure Switch

Part Number	6G12N1.12	6G12N1.14
Adj. Range	0.36 - 3.61 psi (10" - 100" WC)	2 - 16 psi (55" - 443" WC)
Deadband	0.027- 0.144 psi (0.75" - 4" WC)	0.072- 0.25 psi (2" - 7" WC)
Proof Test	250 psi	250 psi

How to Order

(Example: Part Number 6G12F1.03)

6 G 12 F1 .03

Range

- 01 2 - 15 psi
- 03 5 - 75 psi
- 43 15 - 200 psi
- 53 50 - 450 psi
- 62 50 - 1000 psi
- 63 100 - 1750 psi
- 64 200 - 2500 psi
- 73* 350 - 3250 psi
- 83** 400 - 4000 psi
- 84** 500 - 5000 psi

Diaphragm

- N1 Nitrile Polyamide
- F1 Viton Polyamide
- F2 Viton Stainless Steel
- F6** Viton Polyamide
- N9* Nitrile SST Piston Teflon

Electrical Connection

- 12 SPDT (Silver)

Pressure Connection

- A AL 1/2"-14 NPT
- C 316SS 1/4"-18 NPT
- D AL 1/4"-18 NPT
- G AL 1/4"-18 NPT
- H** 316SS 1/4"-18 NPT
- P* AL 1/4"-18 NPT
- Z 316SS 1/2"-14 NPT

* Available only for model 6P (Piston Pressure Switch)
** Available only for model 6H (High Pressure Switch)

• Listed by: Underwriters Laboratories Inc.
(File No. E123884) Suitable for Class 1, Groups A, B, C, D; Class II, Groups E, F, G.

Wiring Diagram

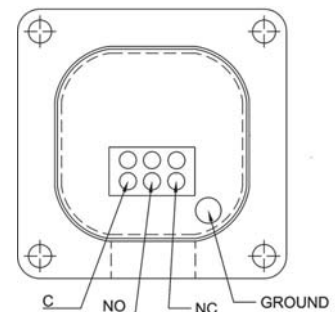



Series 6 Pressure Switch

Dimensional Specifications

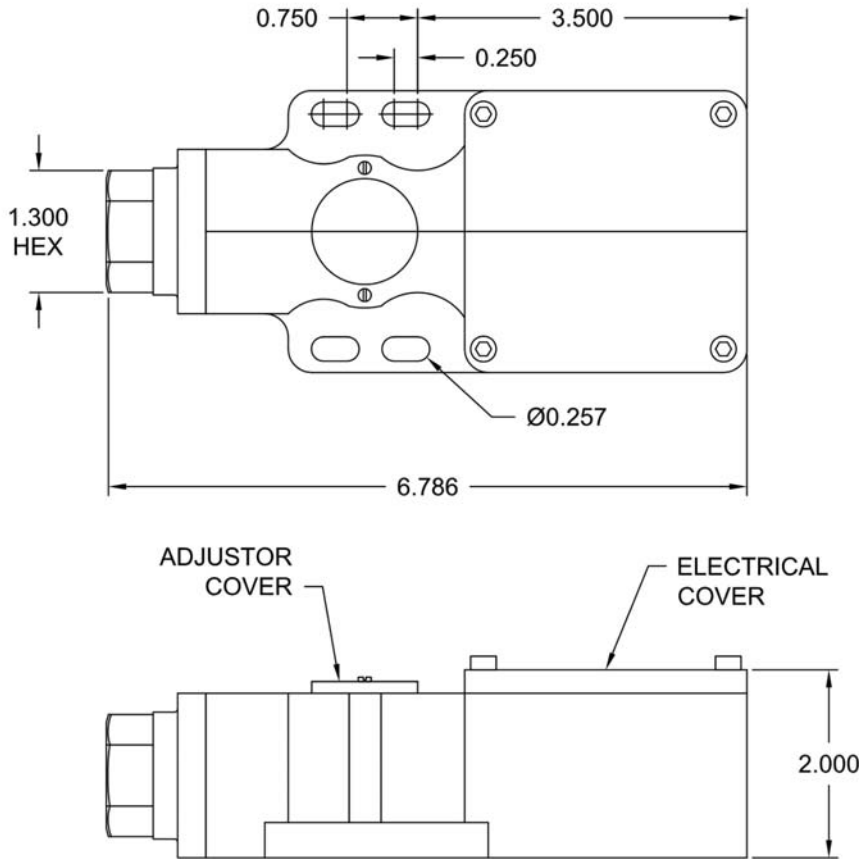

How to Order

(Example: Part Number 6G12F1.03)

6 G 12 F1 .03

Range

- 01 2 - 15 psi
- 03 5 - 75 psi
- 43 15 - 200 psi
- 53 50 - 450 psi
- 62 50 - 1000 psi
- 63 100 - 1750 psi
- 64 200 - 2500 psi
- 73* 350 - 3250 psi
- 83** 400 - 4000 psi
- 84** 500 - 5000 psi

Diaphragm

- N1 Nitrile Polyamide
- F1 Viton Polyamide
- F2 Viton Stainless Steel
- F6** Viton Polyamide
- N9* Nitrile SST Piston Teflon

Electrical Connection

- 12 SPDT (Silver)

Pressure Connection

- A AL 1/2"-14 NPT
- C 316SS 1/4"-18 NPT
- D AL 1/4"-18 NPT
- G AL 1/4"-18 NPT
- H** 316SS 1/4"-18 NPT
- P* AL 1/4"-18 NPT
- Z 316SS 1/2"-14 NPT

* Available only for model 6P (Piston Pressure Switch)

** Available only for model 6H (High Pressure Switch)